

Article number: 2011321650M30A

Description: E+G Holding bushes for lifting pins,
GN 1132-16-50-M30-A

Measures

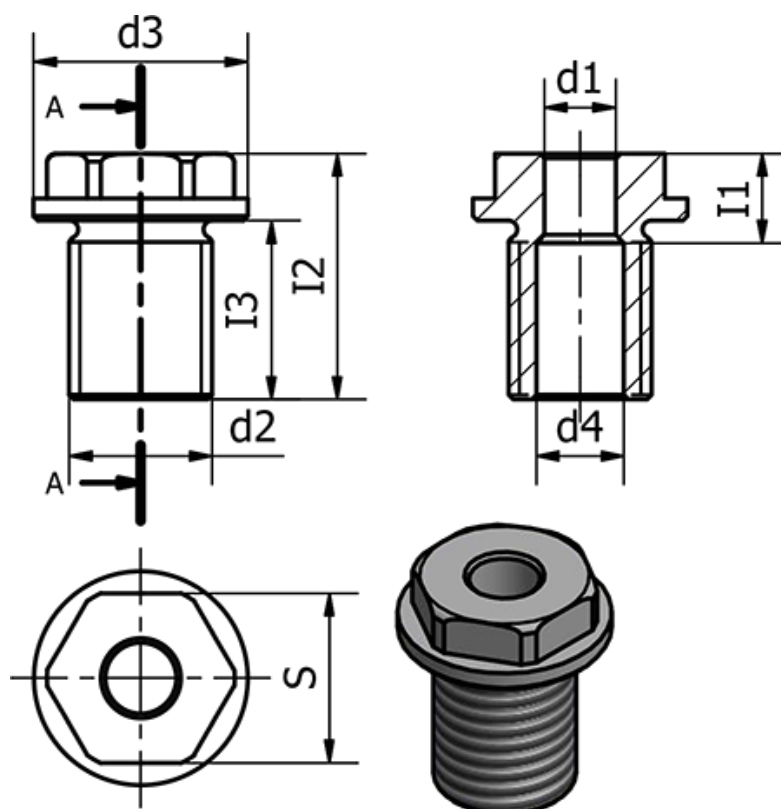

d1 = 16
d2 = M30
d3 = 39
d4 = 19.2
I1 = 50
I2 = 66
I3 = 44
s = 30

Tightening torque in Nm = 400